



# MONSTER TECHNOLOGY – 2019

# SIAPA KAMI?

Kami adalah **Triple One Global**, perusahaan yang bergerak di bidang teknologi sejak tahun 2010, dimulai dari penyedia content melalui jaringan operator, penyedia tenaga kerja, multimedia dan sejak 2014 melakukan pengembangan otomasi, piranti lunak, piranti cerdas, augmented reality, virtual reality dan perangkat keras untuk kebutuhan militer.



Military Product



Machinery Product



AR & VR Product



Content Provider Services



IT Outsourcing Services



Culinary Product



Indonesian Worker Platform



Real Estate Crowdfunding Startup



# BUSINESS UNIT

PT TRIPLE ONE GLOBAL



**CONTENT PROVIDER**



**HR SERVICES**



**IT SOLUTIONS**

2019

# TENTANG KAMI

100++

All Team  
Member

4

Office  
in Indonesia

1

Office  
in Singapore

2

R&D Workshop  
in Indonesia

50++

Client &  
Partner



# 2019

## MENGAPA KAMI?



Perusahaan IT yang berpengalaman



Kuat di pengembangan



Fasilitas & Team yang solid



Memberikan Solusi



# OUR PRODUCT

Perfection of Hardware Quality, High Technology, and Easy to Use is the Best Choice for Your Business Solution.



## Military Technology

[MORE INFO](#)



## IOT Security

[MORE INFO](#)

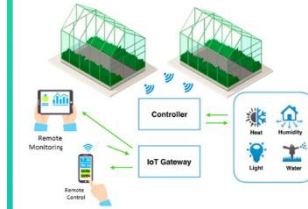

## Smart Tani

[MORE INFO](#)



## Automation Control

[MORE INFO](#)

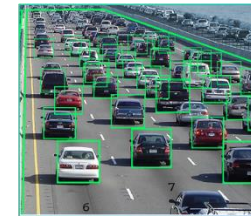

## Computer Vision

[MORE INFO](#)



## Vending Machine

[MORE INFO](#)



## Touchscreen Kiosk

[MORE INFO](#)



## Hot Stamping Machine

[MORE INFO](#)



# AUTOMATION **TECHNOLOGY**

2019

# 2019 – MILITARY DART SYSTEM



***MOVING TARGET***



***POPUP TARGET***



***FLIP TARGET***



2019

# 2019 – MILITARY DART SYSTEM



***POPUP FLIP COMPACT***



***POPUP PLAT TARGET***

# 2018 – MILITARY APPS



# SENSOR DATA ACQUISITION

# 2019 – MILITARY SCORING SYSTEM

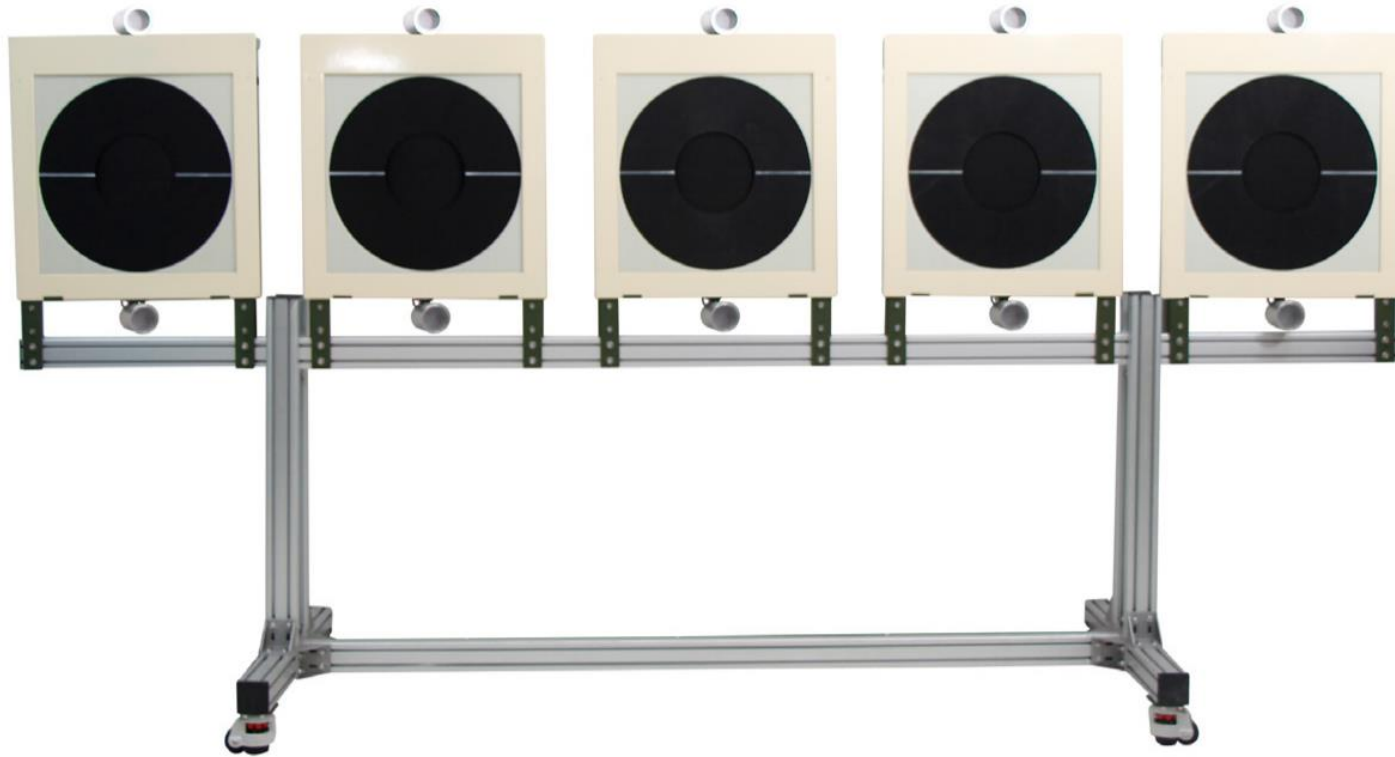

*25m Laser Score*



*10m Laser Score*

2019

# 2019 – MILITARY SCORING SYSTEM

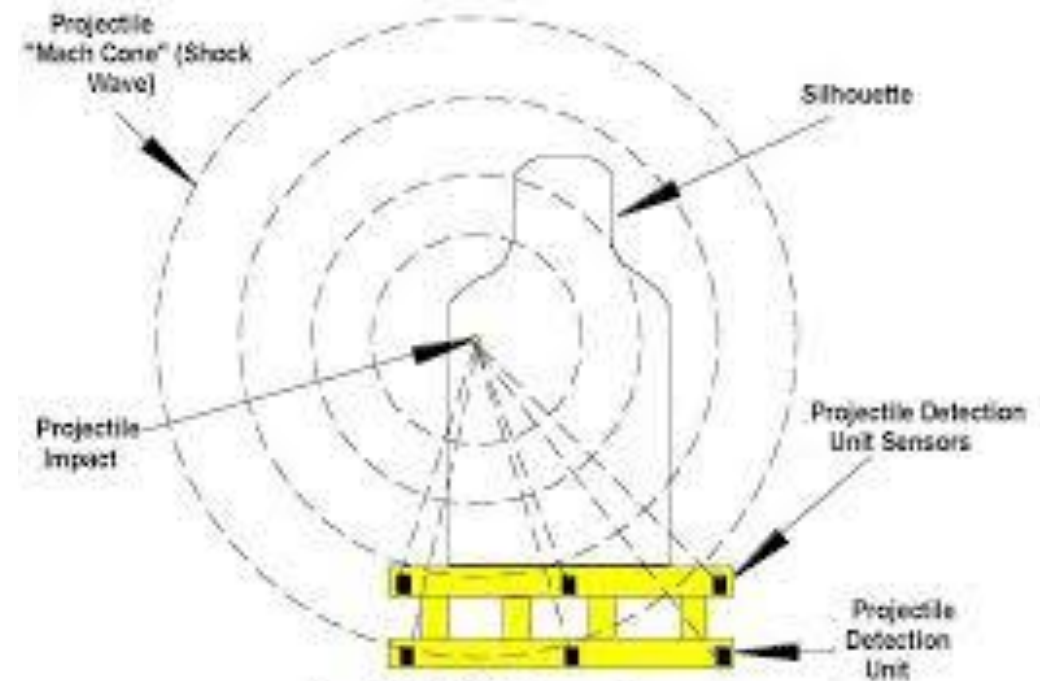
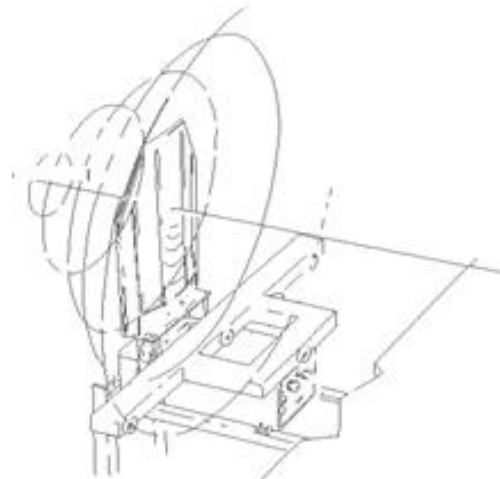
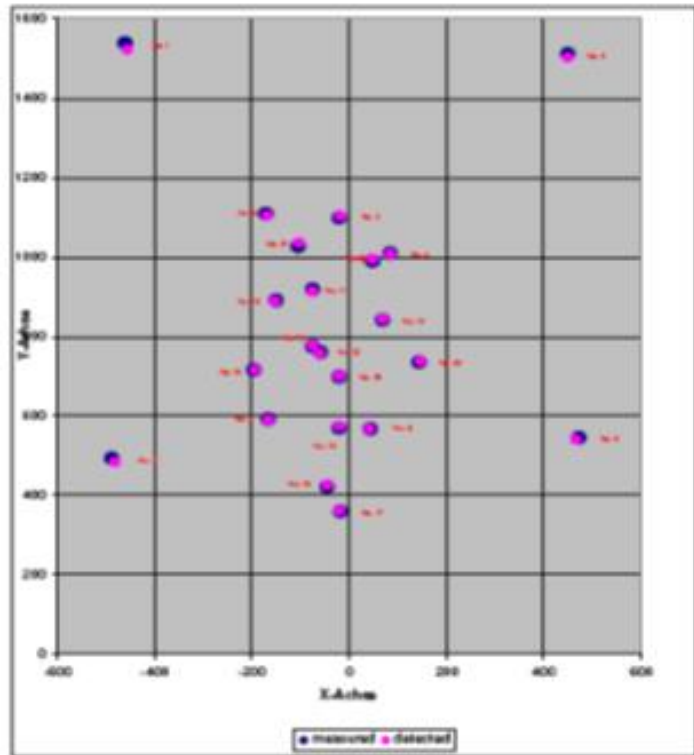

Figure 1 LOMAH Theory of operation.

***Location Of Miss And Hit (LOMAH System)***

# COMPUTER **VISION**

# 2019 – MILITARY SCORING SYSTEM

Shooting Target Monitoring System

File

 **SHOOTING TARGET MONITORING SYSTEM**  
Military Technology Indonesia

Shot round : 3 (15)

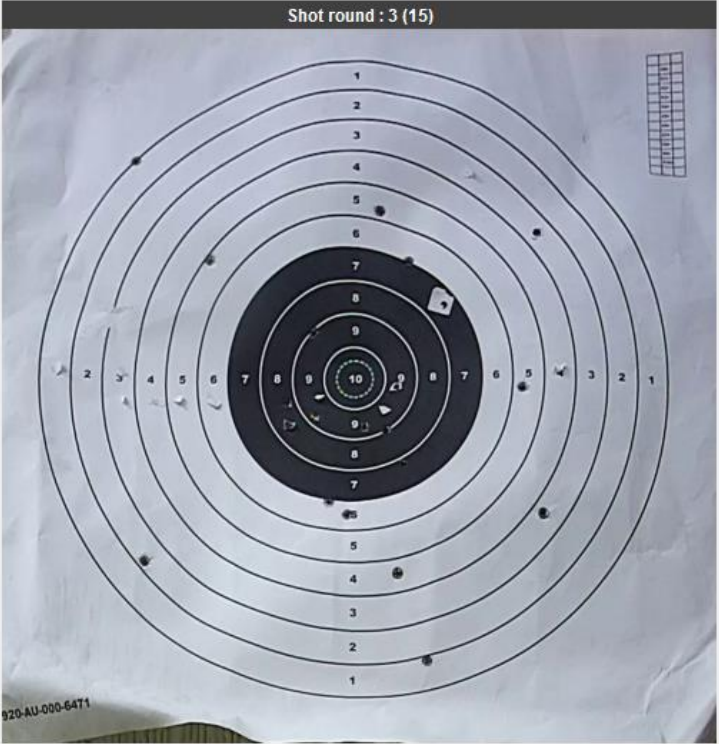

Shot history

Save shot

New project

Shooting Score		
No	Score	Hit point
1	4	830,504
2	1	506,1002
3	0	613,1000

FINAL SCORE **5**    AVERAGE SCORE **1.66666...**    LAST SCORE **0**

Camera connected !!    Reset shot    Get score    Settings    Prepare    Exit

*Image Processing  
Scoring System*

IOT  
**SMART TANI**



70%

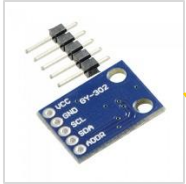
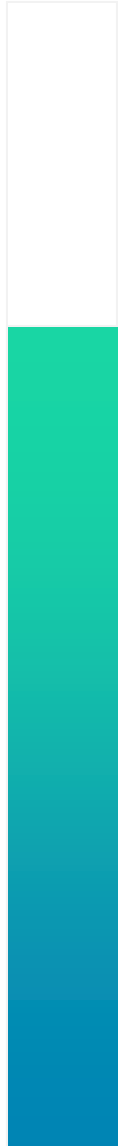

CAHAYA



SUHU AIR



SUHU &  
KELEMBAPAN  
UDARA



TDS/EC



PH AIR



ONLINE SERVER



RASPBERRY Pi



PH UP DOWN



AB MIX



POMPA AIR

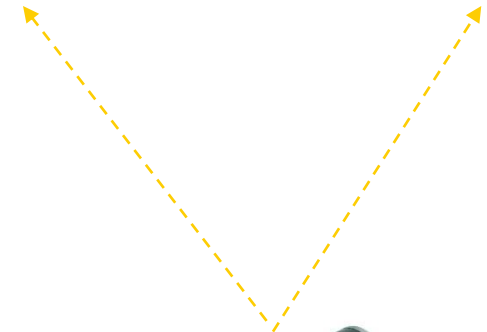
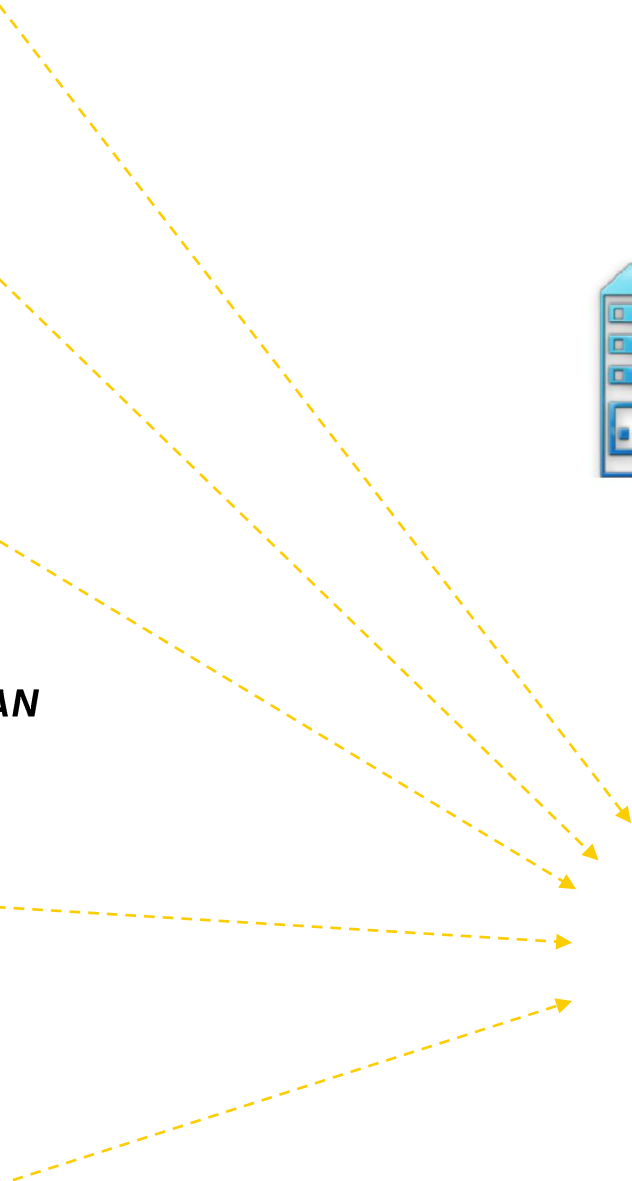

IOT  
**ATM SECURITY**

# IOT SMART ATM SECURITY

## APLIKASI :

1. **Sensor motion** untuk mendeteksi adanya orang saat minimarket tidak beroperasi
2. **Sensor getar** untuk mendeteksi casing mesin ATM dirusak
3. **Sensor cahaya** untuk mendeteksi cahaya las
4. **Sensor panas** untuk mendeteksi brankas di las
5. **Sirine** untuk peringatan kepada pelaku pembobolan mesin ATM

## BENEFIT :

1. Mesin ATM jadi **lebih aman** karena dilengkapi dengan teknologi pengamanan yang canggih
2. Pengawas mendapat informasi tindak kejahatan / kejadian mencurigakan dari sensor dengan **sangat cepat**
3. **Data sensor dapat diolah & dianalisa** untuk mengetahui kejadian apa saja yang telah terjadi selama mesin ATM beroperasi

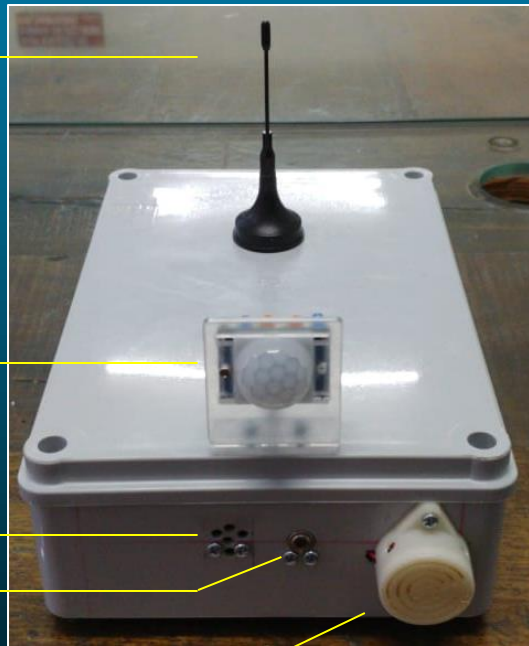

Antena GSM

Sensor Motion

Sensor Cahaya

Sensor Panas

Buzzer

BEACON  
**ADVERTISING**

# 2019 – BEACON ADVERTISING



Dengan beacon, apps dapat mengetahui jarak Antara hp dengan posisi beacon



Bluetooth Low Energy  
(BLE)

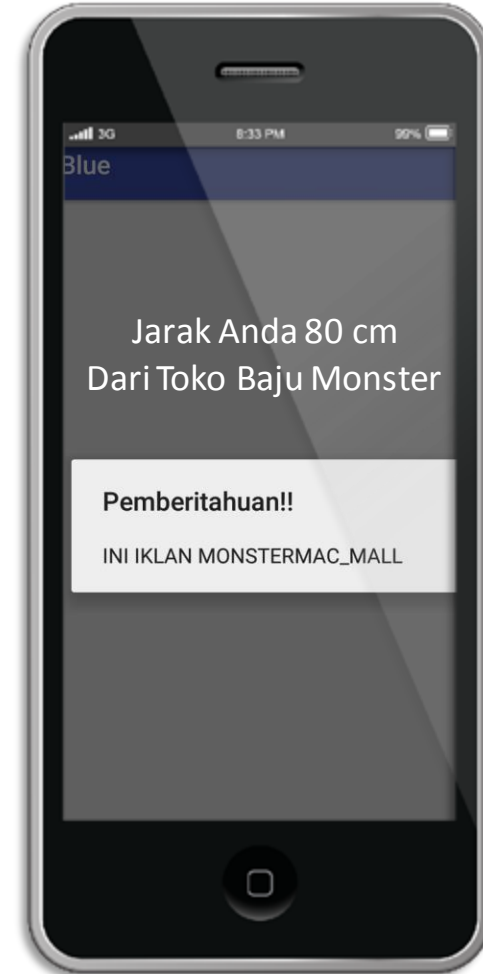

# VENDING MACHINE

# 2019 – KFC VENDING MACHINE



**KFC KEMANG**



**KFC CIRACAS**



**KFC MM BEKASI**

# 2019 – KFC VENDING MACHINE

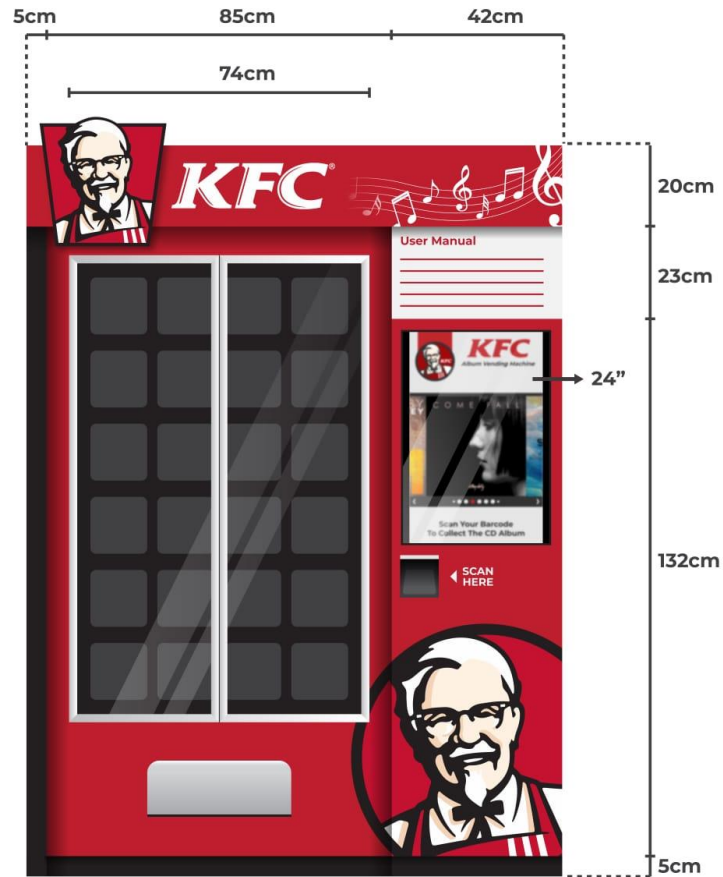

**KFC VM NEW DESIGN**



**KFC VM NEW DEVELOPMENT  
(STORE KALIMALANG)**



# HOT STAMPING **MACHINE**

# 2019 – HOT STAMPING MACHINE

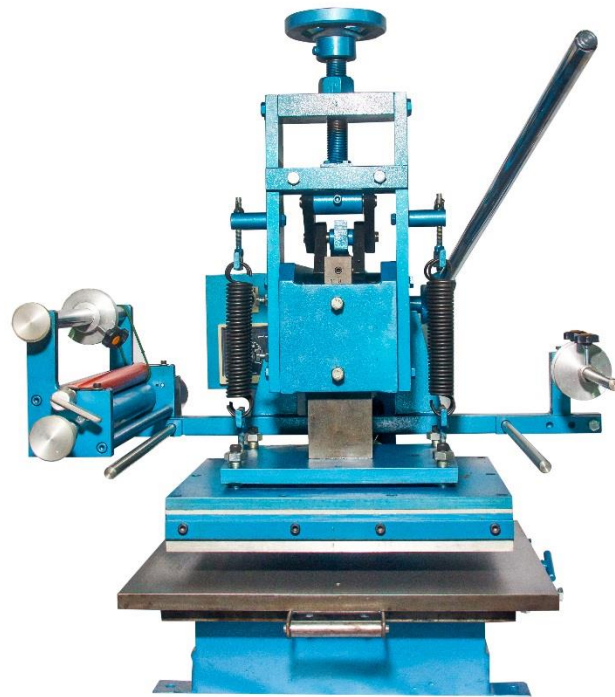

THANK YOU